



CAMLINX

Zero

User Manual



Important

Powering up the Camlinx II

The Tramlines system takes up to 60 seconds to power up.

During this time, video and audio passed by the system is unreliable and should be ignored.

Disclaimer

All information contained in this manual is believed to be accurate and reliable. However, Volamp Ltd assumes no responsibility for its use. Since conditions of product use are outside our control, we make no warranties express or implied in relation thereto. We therefore cannot accept any liability in connection with any use of this information.

This product is not intended for use in life support appliances, devices or systems where a malfunction of the product can reasonably be expected to result in personal injury. Use of any Volamp product in such applications is expressly prohibited.

Whilst every effort has been made to ensure that this document is correct, errors can occur. If you find any errors or omissions please let us know, so that we can put them right

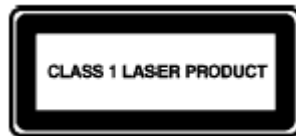

Laser Safety

Invisible laser radiation. Class 1 lasers are used in this product for fibre optic communications. The wavelength used is in the infra-red band so the light emitted cannot be seen. Although the levels are low and are classified as safe under all conditions of normal use, we recommend that users avoid looking directly into the beam.

Trademarks

Camlinx II is a trade mark of Volamp Limited.

Opticalcon ® is a registered mark of Neutrik AG

Table of Contents

Important.....	2
Powering up the Camlinx II.....	2
Disclaimer	2
Laser Safety.....	2
Trademarks.....	2
1.Introduction.....	5
1.1.Camlinx II : Block Diagram.....	6
2.Camlinx II Units.....	7
2.1.Camlinx II : Base Unit.....	7
2.2.Camlinx II : Head Unit.....	8
2.3.Dimensions and Weights.....	9
3.Camlinx II Configurations.....	10
4.Quick start guide.....	11
5.Camlinx II Features.....	12
5.1.Video	12
5.2.Audio	12
5.3.Displays.....	12
5.4.Thumb wheel Switches.....	12
5.5.USB System Updates.....	13
5.6.Battery Mounting Plate.....	13
5.7.Tri-Level / Bi-Level sync.....	14
5.8.Serial Data.....	14
5.9.Timecode.....	14
5.10.Ethernet.....	14
5.11.Power over Ethernet.....	15
5.12.HDMI.....	15
5.13.Sync.....	15
5.14.Tally.....	15
5.15.Convergence.....	16
5.16.GPIO.....	16
5.17.Talkback.....	17
6.System Settings.....	17
6.1.Screenkeys display.....	17
6.2.Fibre Level bars.....	19
6.3.Base Unit : Settings adjustment.....	20
6.4.Head Unit : Settings adjustment.....	22
7.Connectors.....	24
7.1.Talkback - 5 way XLR connectors	24
7.2. Base - Serial 1 & 2 connector pin assignments.....	24
7.3.Base - 26 Way D-Type Connector pin assignments.....	25
7.4. Head - Serial 1 & 2 connector pin assignments.....	25
7.5.Head - +12V local power connector.....	26
8.Power	27
8.1.Introduction.....	27
8.2.Base power indication.....	27
8.3.Hybrid fibre/power cable.....	27
8.4.Camera low battery warnings with 52V power.....	28
9.Troubleshooting.....	29
9.1.Fibre	29

9.2.Power.....	29
10.Accessories.....	30
11.Ordering information :	30

1. Introduction

Camlinx Zero is a low cost system for multiplexing video, talk-back and control signals onto fibre-optic cables for transmission between a camera and a production facility. This provides the following benefits;

- Greatly increased transmission distance over copper cable
- increased bandwidth / data rates
- reduced cable thickness/bulk
- reduced susceptibility to EM interference

The head and the base units of a Camlinx Zero system use the same hardware. A Camlinx Zero system (CZero) comprises of a Base unit which resides in the production area and a remotely mounted Head unit. The two units are connected by a fibre optic cable containing two fibres.

The CZero system has a USB based upgrade facility which allows users to upgrade their systems in the field from a USB stick . This feature allows the user to incorporate new features and enhancements quickly and reliably.

Settings on the base and head units can be adjusted using three position switches mounted on the front of the units. These switches can be moved from left to right and also have a centre push position. When using these switches the user must press and hold the switch in the desired position until he sees the setting change on a LED display.

Both the head and the base use LED displays to display system information.

Fibres into the head unit use the LC connection system.

The Camlinx Zero head unit is powered from a local 12Vdc supply.

There are three systems in the Camlinx II range of fibre systems. These are ;

1. Camlinx II High end system with optional support for 3G applications.
2. Camlinx II Lite Mid range system
3. Camlinx II Zero Low end system for applications not requiring audio.

See website for further details.

1.1. Camlinx Zero : Block Diagram

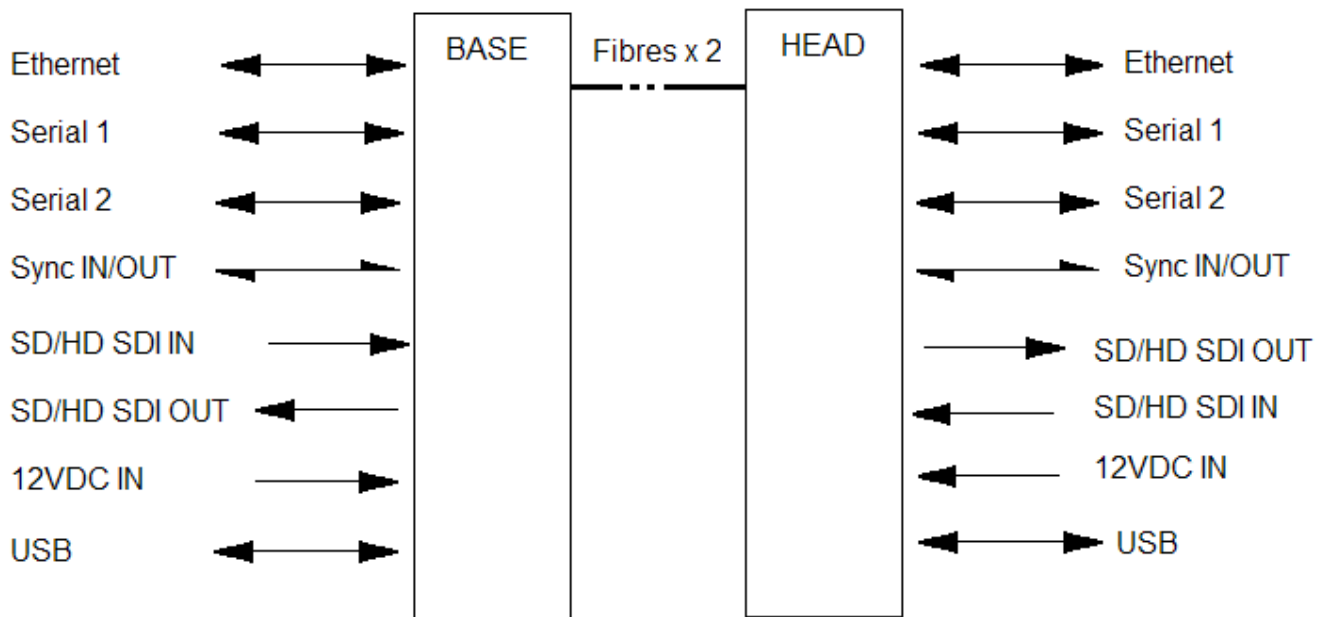

CAMLINX Zero : Block diagram

2. Camlinx Zero

2.1. Camlinx Zero: Enclosure (Head and Base)



2.2. Dimensions and Weights

	Dimensions Width x Height x Depth (mm)	Weight (kg)
BASE and Head	137.2 x 40.4 x 143.2 mm	

3. Fibre

The standard Camlinx 2 system is designed to use 9 µm single mode fibre and will not work with multi-mode cable.

Camlinx II will operate over existing 9µm installation cabling assuming it is in good condition and cable lengths are not exceeded (<300M for hybrid cable).

The system will not operate through fibre optic switching equipment such as Ethernet hubs, SMPTE video switches, etc.

The minimum fibre length for the Camlinx 2 is 10km however much greater distances are possible . Please contact Volamp Ltd if longer distances are required.

4. Quick start guide

1. Make system connections according to chosen system configuration. Ensure all cables are connected to the system.
2. Turn on mains power to the base and head.
3. Set the serial communications standard (RS232 by default). If a remote control panel is used, check its operation.
4. System should be operational.

5. Features

5.1. Video

The Camlinx II Zero system supports the following video standards;

Video Standard	SMPTE	Supported
Composite NTSC/PAL	170M	Yes
SD-SDI 270MBit PAL	259M	Yes
SD-SDI 270MBit NTSC	259M	Yes
HD-SDI 1485MBit 1080 50i, 25p, 60i, 30p, 24p	292M	Yes
HD-SDI 1483MBit 1080 59.9i, 29.9p, 23.9p	292M	Yes
HD-SDI 1485MBit 720 60p	292M	Yes
Ethernet		10/100Mb/s

5.2. Thumb wheel Switches

Settings on the Base and Head units are adjusted using two thumb wheel switches (SW1,SW2). These have three positions which are to the left, to the right and centre push. **When using these switches the user must press and hold the switch in the desired position until the LCD display changes.**

On the base, the two front rocker switches are used to change settings on the LCD display only. On the head, the switches are used to adjust settings on the screenkeys display.

5.3. USB System Updates

Camlinx Zero has a USB upgrade facility which allows users to upgrade their systems in the field from a USB stick.

System upgrades files are available by;

- a) USB stick from Volamp or Volamp Distribution
- b) Email attachment from Volamp or Volamp Distribution
- c) File download from the website.

To upgrade a Camlinx Zero unit, files must be loaded onto a USB stick. The main programming file will have a .jic extension and contains a hardware and software configuration.

Apply power to the head or base unit and allow it boot up as normal. Insert the USB

stick into the front of the unit and leave the system for 5 minutes,. After the unit has reconfigured it will automatically reboot itself so the system is ready for use. Remove the USB stick.

Volamp recommend the use of SANDISK USB sticks for this purpose.

5.4. Mounting Plates

A camera battery mounting plate can be attached to the units if required. The mounting holes are present on the enclosure for this. In addition, a wall mounting plate is available .

The system can be supplied with different battery mounting plates on the head unit which should be specified when placing your order. The following plates are supported;

1. Anton Bauer
2. PAG PagLok
3. Sony V-lok

5.5. Tri-Level / Bi-Level sync

This feature allows gen-locking of cameras. A sync signal connected to the sync input on the base will appear at the sync output on the head for connection to the camera. Both bi-level and tri-level (HD) syncs are supported. The sync connections on the head and the base can be either inputs or outputs. If a sync signal is connected to the base unit, the sync connection will configure itself as an input and the sync connection on the head will automatically become an output and vice versa.

5.6. Serial Data

Two full-duplex serial channels with a maximum data rate of 500KBit/second are provided. All channels can be configured as RS232 or RS422 using the menus on the base. Please contact Volamp if support for RS485 is required.

Serial channels 1&2 appear on 9 way D-type connectors.

Note the crossover of the serial signals between the head and the base.

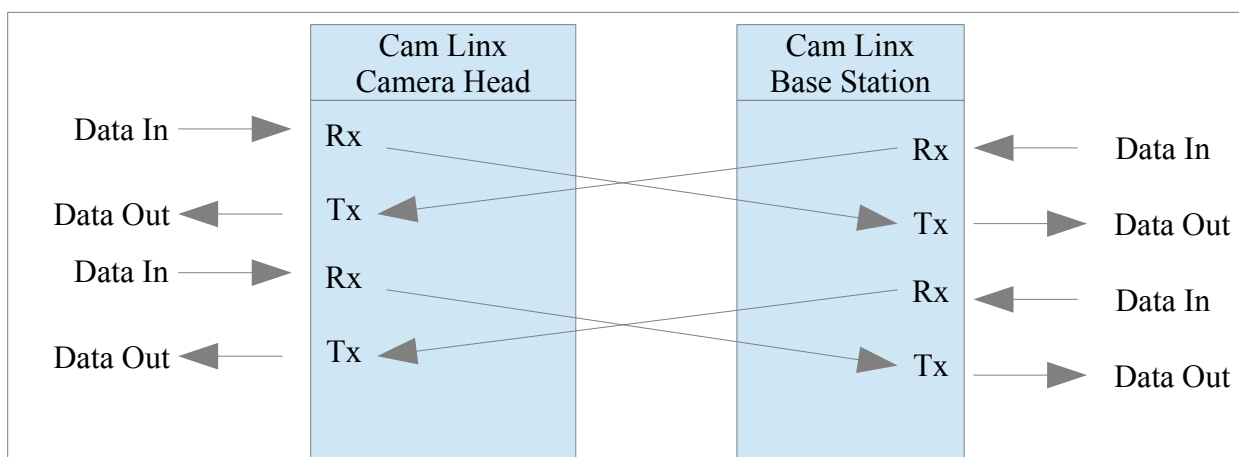

5.7. Timecode

The system passes Time Code (LTC) between the head and the base.

Frequency of operation 960hz – 2.4 kHz.

24,25 or 30 frames of timecode per second with 80 bits per frame.

5.8. Ethernet

10/100 Ethernet is passed transparently between head and base for ;

Computer networking

Camera control

Pan and tilt control

LAN / WAN access.

RJ45 connectors are present on the head and base units.

5.9. Power over Ethernet

48V up to a maximum of 20W is available at the base Ethernet connector for powering control panels.

5.10. HDMI

The HD-SDI input video channel from the head is output on the HDMI connector at the base .

5.11. Sync

This feature allows gen-locking of cameras. A sync signal connected to the sync input on the base will appear at the sync output on the Camlinx II head for connection to the camera. Both bi-level and tri-level (HD) syncs are supported.

5.12. Tally

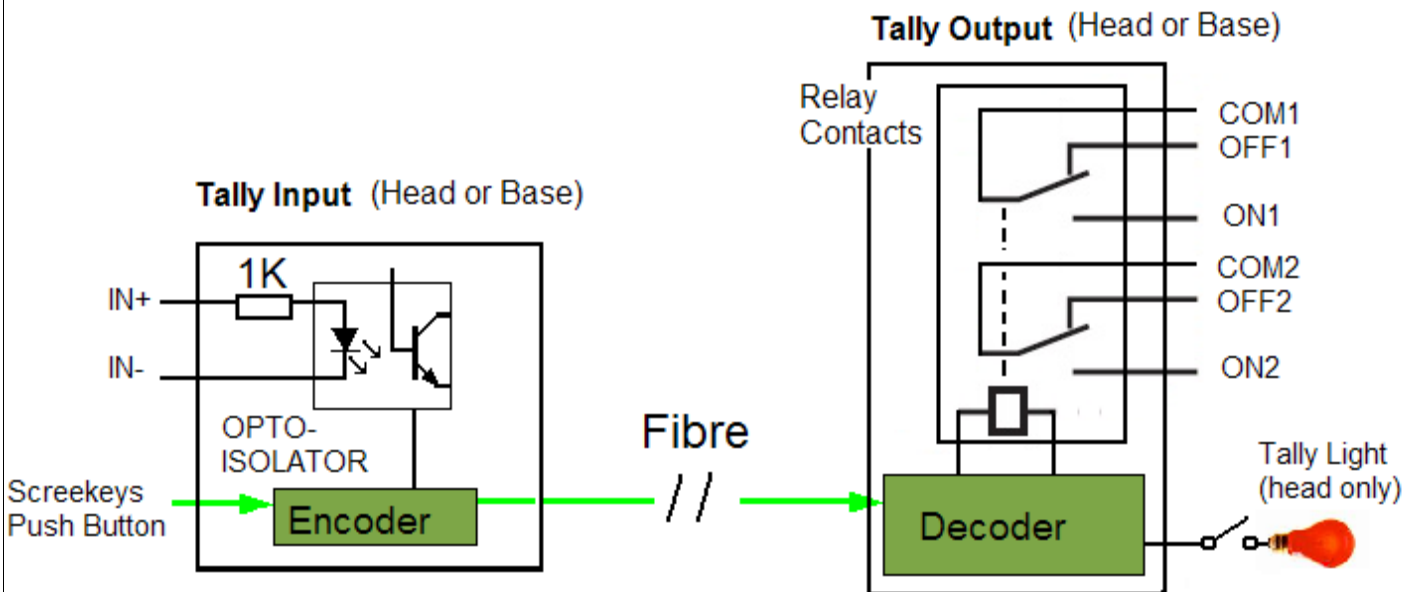

Camlinx II incorporates a bidirectional Tally system used to provide an on-air indication at either the head or the base. Connections to the Tally system appear on the 26 way D-type connectors present on the head and base units. The head has a dedicated Tally LED indication on the top of the unit which incorporates a push-button switch so it can be manually disabled.

In addition, there is an 'optical Tally' light output on the head which will be illuminated. A 'light guide' (OT-CAMLINXII) can be connected to this output which can be mounted in the camera eyepiece (or elsewhere) so the operator can always see the the Tally indication.

Passing a current between IN+ and IN- closes the connections between Common1 / On1 and Common2 / On2 which can be used to drive indications.

Tally indications can also be driven by the Screenkeys push-button. The screenkeys button has a dual function, primarily to configure the audio settings but it will also drive the Tally indication when the system is on air. This is in addition to the Tally inputs being able to drive the Tally indication.

5.13. Convergence

Provides an analogue voltage from the base to the head for setting the convergence point on 3D cameras. This voltage is sampled and updated 20 times per second and is in the range 0 to +5V.

The Convergence pins appear on the 26 way D-type connectors present on the head and base units.

5.14. GPIO

There are 4 digital GPIO (General Purpose Input Output) pins in each direction across the fibre link.

Signals onto the GPIO pins must be at TTL levels

Document No. : UserManual_CII_1

Input Low < 0.7V

Input High >3V up to a maximum of 6V

Maximum switching frequency of 500KHz.

The GPIO pins appear on the 26 way D-type connectors present on the head and base units.

5.15. Talkback

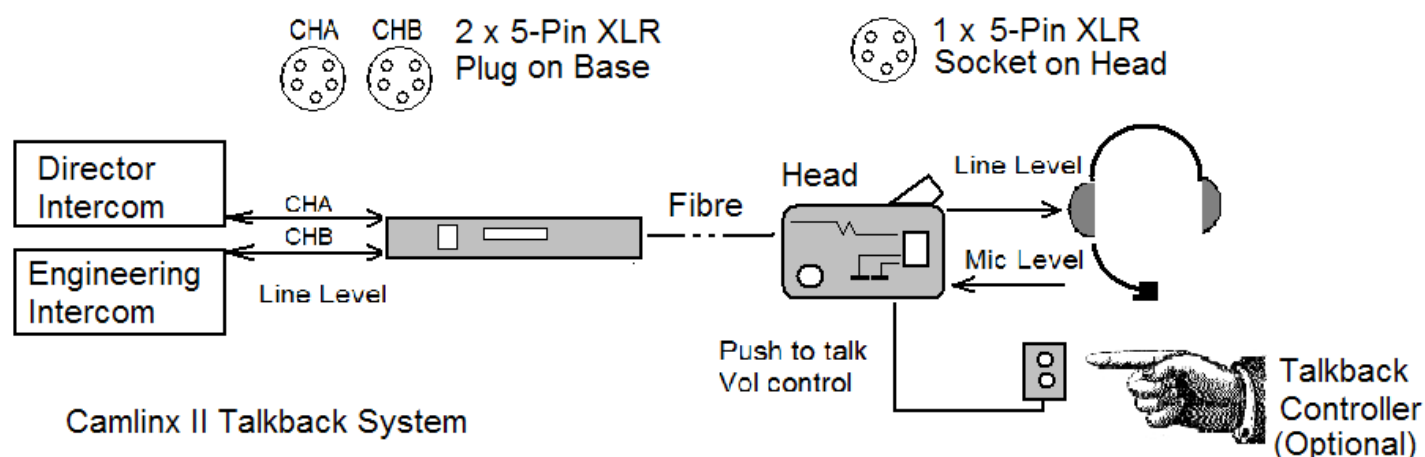

Camlinx II can support one or two channel talkback systems. The base unit accepts two five pin XLR connectors, one for channel A and the other Channel B. The Head has one five pin XLR connector for a standard headset. Audio from both channels can be received into the headset either as a single channel in each ear or both channels mixed and into each earpiece (see section on head settings).

A talkback controller is available which plugs directly into the Camlinx II head. This allows the user to adjust the headphones volume remotely from the head unit. It also includes a 'push to talk' button which enables the headset microphone. If a Talkback controller is not used, the sound is continuously enabled and volume control is adjusted using the three way rocker switch SW1 on the head unit.

The headphones' microphone can be disabled using SW2 on the head unit.

6. System Settings

6.1. Screenkeys display

Screenkeys colour displays are present on both the head and the base units and provide system information to the user. As the head unit does not have an 16x2 LCD, additional information is displayed on the head display. See following table.

FIBRE LEVEL

◀ local
 ▶ remote

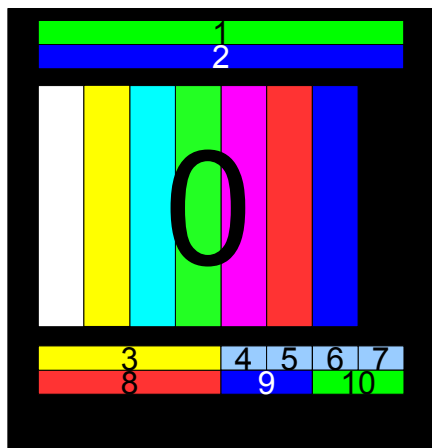

Numbers on the screen refer to entries in the table below.

	Description	Colour	Notes
0	Camera Number	Black	Set at base
1	Fibre Level % - Local	Green	
2	Fibre Level % - Remote	Blue	
3	Fibre Driver Temperature	Yellow	
4	Audio CH1 :		Head only
	Phantom	Orange	
	Line	Blue	
	Mic	Purple	
5	Audio CH2 :		Head only
	Phantom	Orange	
	Line	Blue	
	Mic	Purple	
6	Headphones :		Head only
	Individual	Cyan	Channel 1 in right headphone, channel 2 in left headphone.
	Combined	Pink	Channels 1 and 2 mixed and driving both headphones
7	Mic Level :		Head only
	Silent	Grey	
	Line	Blue	
	Mic	Purple	
8	Core temperature	Red	
9	Call Indicator	Blue	
10	Tally Indicator	Green	

6.2. Fibre Level bars

At the top of the screenkeys displays are two horizontal bars which give an indication of fibre light levels. The local level is the received level at the unit on which the display is mounted (could be head or base). The Remote level is the receiver light level at the unit at the far end of the fibre.

The fibre level bars should lie between 20 – 90% for correct operation.

If the level falls too low, the bar will change to red in colour and reliable operation cannot be guaranteed.

In addition, if communications between the head and base are not locked, the bars will change to grey in colour. (see below)

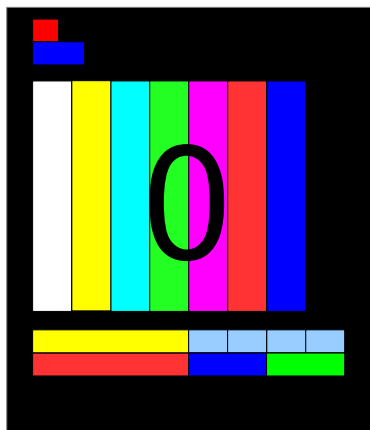

Fibre level low indication

A red indication on the fibre level bars means the level is too low for reliable operation.

Action :

1. Ensure fibre connectors are correctly inserted.
2. Check and clean fibres.
3. Check for damaged or broken fibres.
4. Ensure correct fibre in use.

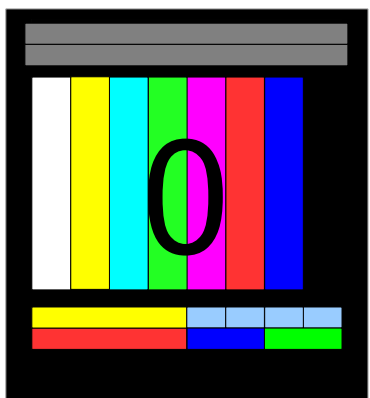

Fibre Communication not locked between head and base.

A grey indication on the fibre level bars means the system is not locked.

Action :

1. Turn the system off and on (cycle the power).
2. Check fibre connections.
3. Contact Volamp or authorised distributor.

6.3. Base Unit : Settings adjustment

In addition to the screenkeys display, the base unit has a 16x2 character LCD which is used when adjusting system settings.

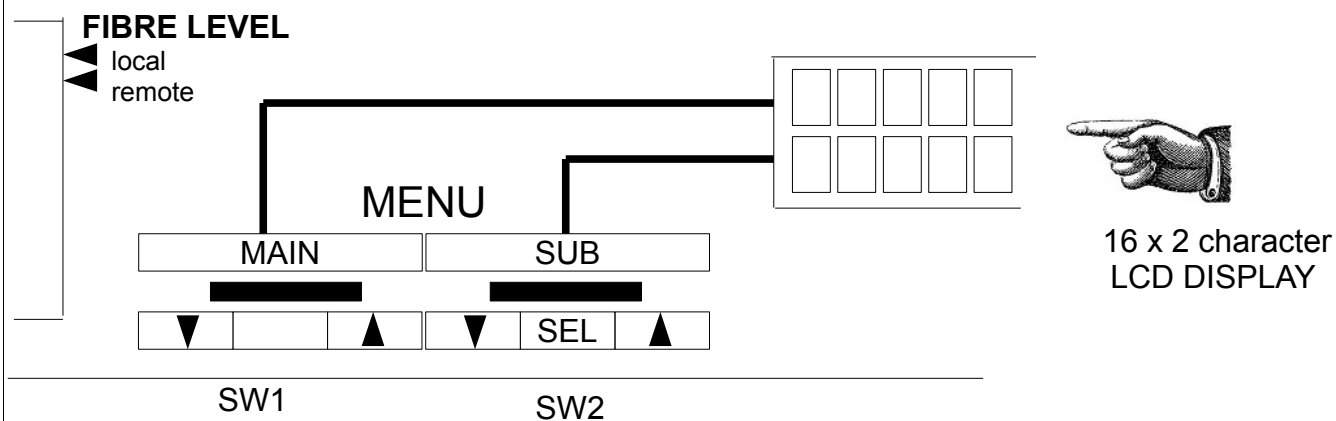

Base : Switches and LCD display

The left switch (SW1) navigates up and down through the **main menu** options while the right switch (SW2) navigates through the **sub menu** options. System settings and system information are accessed via these switches.

Once the correct sub menu has been selected, the user must press and hold the centre button on SW2 until (→) appears. The sub menu can then be adjusted with SW2. To confirm the setting, press and hold the centre button of SW2 until (→) disappears.

The following table lists the options available using the base LCD.

	Main Menu Options		Sub Menu Options		SELECT - >	INFO
	SWITCH 1		SWITCH 2			
option	(NOTE 1)	option	(NOTE 2)	option	(NOTE 3)	(NOTE 4)
1	CAMLINXII	1	FPGA Head Temp.			55^C
	BASE	2	FPGA Base Temp.			56^C
		3	PCB Issue No.			1
		4	Unit ID			0475ae
		5	Software			2660
		6	Firmware			N/A
		7	Start Temp			40^C
2	AUDIO	1	Left	1	Line	
		2	Right	2	Mic	
3	COMP CH2 SET			1	Enabled	
				2	Disabled	
4	STD	1	STD SDI Output			Unknown
		2	STD CVBS Input 1			
		3	STD CVBS Input 2			
		4	STD SDI Input			
		5	STD CVBS Output			
5	CAMERA NUMBER			1	1	
				2	2	
				3	3	
				4	4	
				5	5	
6	TALLY OUTPUT	1	Local	1	LOCK ON	
		2	LED	2	LOCK OFF	
		3	Remote	3	STD	
				4	INV	
7	SERIAL RX TX	1	CH1	1	RS232	
		2	CH2	2	RS422	
		3	CH3			
8	FIBRE		Local			DRIVER (SFP) Temp
			3G1			Fibre Loading
			3G2			Status
			Remote			
NOTES						
1	Push left or right to scroll up/down the Main Menu options listed below					
2	Push left or right to scroll up/down the Sub Menu options.					
3	Press and hold the centre button of Thumbwheel2 (right hand side) until the (- >) appears.					
	Change the setting by pressing Thumbwheel 2 to the right or left.					
	To confirm the setting, press and hold centre button of Thumbwheel2 until (- >) disappears.					
4	These submenu settings display the system information listed below.					

6.4. Head Unit : Settings adjustment

The two 3 position rocker switches on the head adjust Audio and Talkback functions. **When using these switches the user must press and hold the switch in the desired position until the LCD display changes.**

The screenkeys display also incorporates a push-button. By pressing down on the button, the functions of the two three position rocker switches (SW1, SW2) can be changed between Talkback and Audio functions.

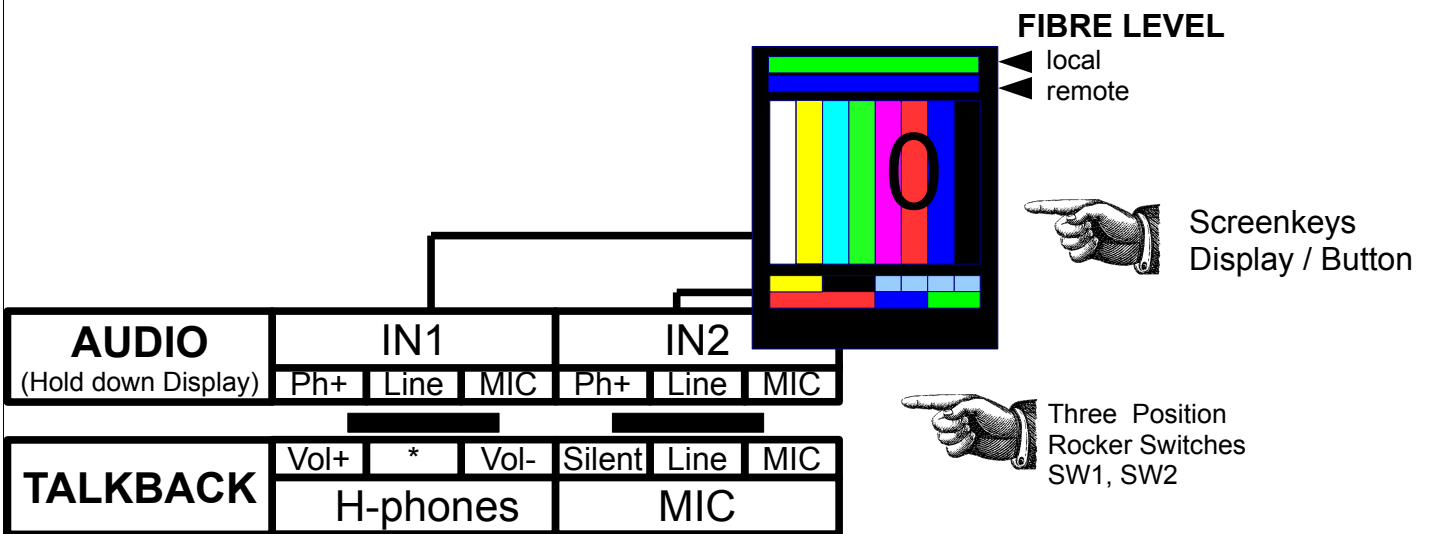

Head : Switch Markings

AUDIO Functions (Press and hold down the screenkeys button to adjust)

Ph+	36V Phantom Power (used to power an external microphone)
Line	0dB (generally 1V)
MIC	Adds +20 dBu gain to the input.

TALKBACK Functions





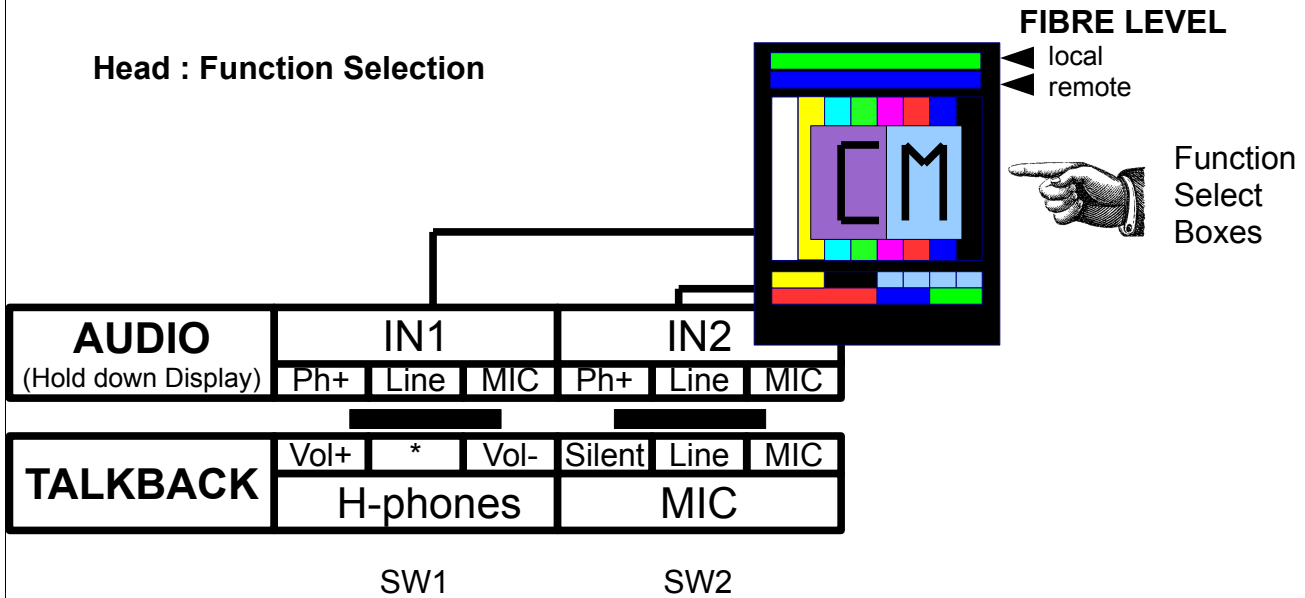

Vol+	Headphones volume control
Vol-	Headphones volume control
*	Combined / Independent – Sound through the headphones is either mixed into each earpiece or separate channels in each earpiece.
Silent	Microphone is muted
Line	0dBu (generally 1V)
Mic	Adds +20 dB gain to the input.

Head : Function Selection



When making adjustments with SW1 and SW2, two 'function select' boxes are displayed on the screenkeys display. The box on the left shows the setting on SW1 and the one on the right shows the setting on SW2

These boxes show the current settings of the Camlinx II head unit. To change the setting press and hold the switch until the setting on the display changes. Release the switch and the display changes back to camera number.

Setting	Function Select Box displays	
Ph+		Phantom Power
Line		Line level input
MIC		MIC level input
Silent		Muted input
*		Individual
		Combined
Vol+		Positive volume control
Vol-		Negative volume control.

7. Connectors

7.1. Talkback - 5 way XLR connectors

	HEAD XLR 5 PIN SKT	BASE XLR 5 PIN PLUG	
Pin		CHA	CHB
1	Microphone +	GND	GND
2	Microphone -	IN-LP+	IN-RP+
3	Ground/screen	IN-LN-	IN-RN-
4	Headphones R	OUT-LN-	OUT-RN-
5	Headphones L	OUT-LP+	OUT-RP+

Talkback Connector	Manufacturer		Mating Connector
Head	Neutrik	NC5FBH (socket)	NC5MX
Base	Neutrik	NC5MBH (plug)	NC5FX

Talkback Controller Connector	Manufacturer		Mating Connectors
Head	Tyco	T01-0560-S04	T01-0550-P04

7.2. Base - Serial 1 & 2 connector pin assignments.

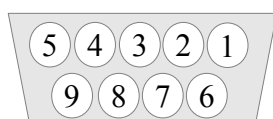

Pin	Function	Pin	Function
1	0V	6	NC
2	TX+ (RS232 / RS422)	7	TX- (RS422 only)
3	RX+ (RS232 / RS422)	8	RX- (RS422 only)
4	12V (200mA max)	9	NC
5	GND		

7.3. Base - 26 Way D-Type Connector pin assignments.

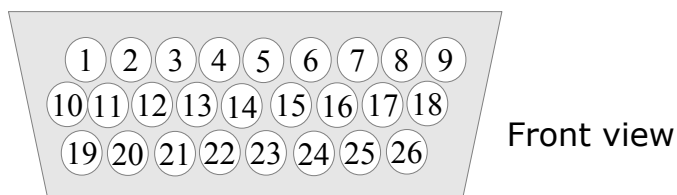

Pin	GPIO	Pin	Tally	Pin	Serial	Pin	Power
1	IN1	8	input+	2	Ch3 RX- *	26	+5V0 out
9	OUT1	18	input-	3	Ch3 RX+	23	+12V out
12	IN2	17	Output Common1	4	Ch3 TX- *	13	GND
11	OUT2	7	Output Off1	5	Ch3 TX+	15	GND
20	IN3	25	Output On1			14	GND
19	OUT3	16	Output Common2				
22	IN4	6	Output Off2				Convergence
21	OUT4	24	Output On2			10	Convergence

*RS422 only.

7.4. Head - Serial 1 & 2 connector pin assignments.

<p>Front View</p>	Pin	Function
	1	TX+ (RS232 / RS422)
	2	TX- (RS422 only)
	3	GND
	4	12V (200mA max)
	5	RX- (RS422 only)

Serial Connector	Manufacturer		Mating Connectors
Head	Tyco	T01-0560-S05	T01-0550-P05

7.5. Head - +12V local power connector.

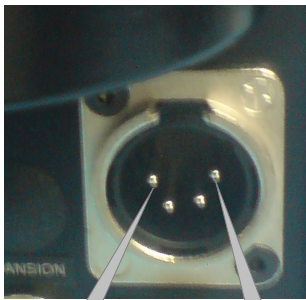

Pin	Function
1	Ground
2	Ground
3	+12V Out
4	+12 to +13.2 Volts DC IN

1

4

12V Local Power	Manufacturer		Mating Connectors
Head	Neutrik	NC4MD-LX	NC4FX

8. Power

8.1. Introduction

The CamlinxII head and base units can be connected with either a Hybrid cable (fibre plus copper power conductors) or a fibre only cable. If a fibre only cable is used, the head can be powered by one of the following;

1. Battery
2. Local +12V supply (front connector on head)
3. Camlinx Power Injector (PI-Camlinx)

The 125W Base power supply is designed to power both the head and the camera. The head power supplies have enough capacity to power most cameras without additional power supply modules.

8.2. Base power indication

On the front of the base unit is a row of vertical green LEDs which indicate the power load on the base. The top most LED is always illuminated when the base is powered up. The other four LEDs show the loading on the base with the lowest LED showing minimal loading, additional LEDs show increased loading on the base



LED	Power Loading	Comment	Rating(W)
5	Base Power indication	Should always be active	
4	Heavy	Upper limit reached for normal operation	125
3	Medium		75
2	Medium / Light	Head and Camera connected	25
1	Light	Head connected	5

8.3. Hybrid fibre/power cable

The Camlinx 2™ power link system operates at 52 volts DC. 52 volts is supplied by the base unit and is converted down to 12 volts at the head. Up to 110 watts (5 Amps) can be supplied to a Camera up to a distance of 130m. At a maximum distance of 300m, the power that can be delivered to the camera will be reduced due to cable losses to approximately half this value. (see graph)

Power losses down the cable are incurred when using hybrid cable. These losses limit the length of cable that can be used as eventually the voltage level at the head will not be sufficient to power the camera. The following graph shows the power losses typical down a hybrid cable.

Camlinx2

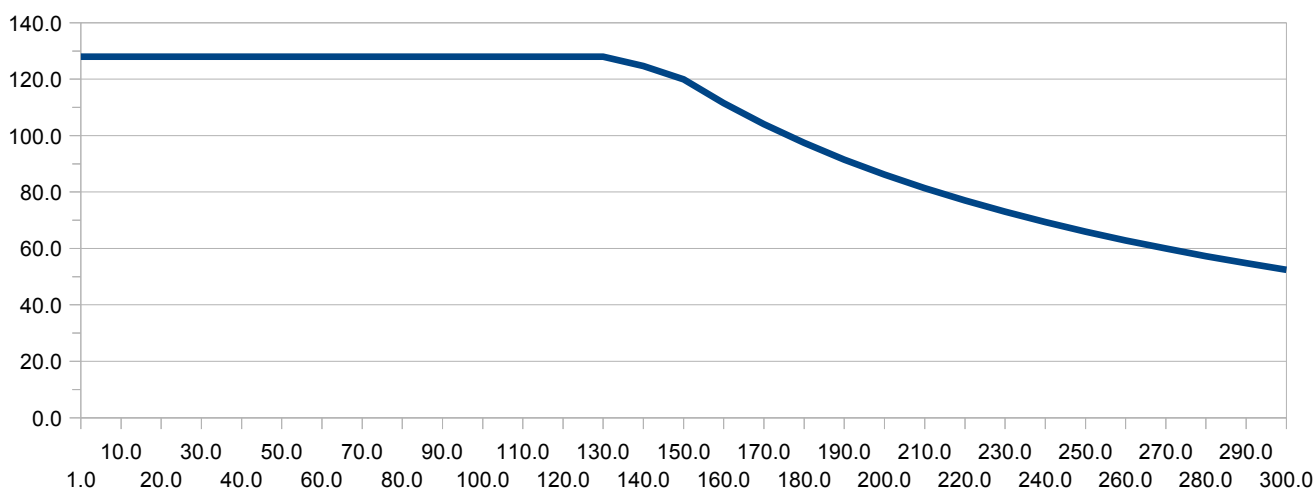

Camlinx II : Power (W) vs Distance (m)

	Power Consumption(Watts)	Output capacity (Watts) with hybrid cable length = 130m
Base	20 (base only)	125
Head	15	110 (available to camera)

Camlinx II Head – 12V Local Power input	Volts DC	
	Min	Max
Supply Voltage Range	9.7	13.2

The Camlinx II head will operate on any supply voltage from 9.7 Volts to 13.2 Volts DC. A minimum of 12 Volts is recommended to ensure the correct voltage at the camera.

8.4. Camera low battery warnings with 52V power

When operating on the 52Volt power system, the Camlinx 2 head delivers 13.2V to the camera. Camera Battery low warning indication should be set to 12V or lower.

9. Troubleshooting

Most problems with this type of system are related to fibre or power issues.

9.1. Fibre

There are two main types of fibre faults;

continuity faults – due to fibre breaks or connectors not seated correctly.

unexplained losses – dirt in fibre connectors, fibre damage.

Connector losses are low. The maximum for a Neutrik Opticon Connector is 0.5dB. Cable losses are also low, typically 0.2-0.4 dB per km. A typical installation will be under 300M of cabling with 2 or 3 connectors per path. The total loss will then be just over 1dB worst case, usually less.

	Cause	Action
1	Badly seated connectors	Unplug and reconnect fibre connections
2	Dirt	Clean fibre ends
3	Broken fibre	replace fibre

9.2. Power

The Camlinx II system puts 52V down the hybrid cable and can deliver 125 watts to the camera/head assembly. Attempting to draw more power than this and the system may not work reliably.

If you have problems, first check that the 52V supply is on. Next check the power meter on the base.

- If no lights are on – the head isn't connected. There is continuity problem, check your cable and connectors.
- If only the bottom light is on – only the head is powered, check your equipment is switched on
- If all lights are on, including the red light at the top, the power supply is overloaded. The user will need to reduce the load on the system or add additional capacity.

An overloaded power supply can be a result of

- 1) A short circuit – check your cables and connectors
- 2) Too much equipment being plugged into the head
- 3) Inrush problems (i.e. surge of power on power on).

If the head is heavily loaded and inrush problems are suspected when the system is powered up, try powering up the base without the hybrid cable connected. Once the head is stable, connect the cable and the head should power up correctly.

10. Accessories

	Accessory	Description	Part number
1	Camlinx Power Injector	Merges separate fibre and power inputs onto a single Hybrid cable. Powered from the mains and supplies 52V down the fibre.	PI-CAMLINX
2	Universal RCP	Camera remote control panel	RCP-2050A
3	Tally Module	Connects to 26W D connector. Gives connectors for Tally, LanC, Convergence	TM-CAMLINXII
4	Talk-back Controller	Remote module with volume control, push to talk feature.	TBC-CAMLINXII
5	Optical Tally	light guide giving red tally light in camera eyepiece.	OT-CAMLINXII
7	Cables	Use the following link for our range of cables; http://www.volamp.com/cables.html	

11. Ordering information

e.g. **CAMLINX2-C-P-S**

A basic Camlinx II system has one bidirectional HD-SDI Video channel. Additional channels can be added (at extra cost) to suit different applications. Please specify the video, battery and connector options required when placing your order;

Option	Description	Code
-C	Connection system	N – Neutrik, L3K – Lemo3K, LH – Lemo Hermaphroditic
-P	Battery mount	AB – Anton Bauer, V – V Lock, P – PagLok, N – none R – Rosenberger (fibre only)*
-S	Fibre Receiver	Blank IN1 & IN2 not fitted 3G additional single 3G/HD/SD fibre channel – IN1 3G-3D additional two 3G/HD/SD fibre channels - IN1 & IN2

* Rosenberger connectors are fibre only, no power.

Contact Information:

Volamp Ltd., Unit 3, Riverside Business Park, Dogflud Way, Farnham, Surrey GU9 7SS.
UK

Email : info@volamp.com
www.volamp.com

Tel : +44 (0)1252 724055